

## NEMP-DCG-025KV (Small sized NEMP simulator)

- Nuclear EMP(NEMP) Simulator is used to simulate EMP signal which is reached on the earth surface by the nuclear weapon explodes at high-altitude(HEMP). NEMP Simulator can be used for EMP radiation immunity test for various electronic devices or systems by artificially creating EMP generation environment.
- Replex have developed the NEMP simulator using a high voltage pulse generator based on fast capacitor charging technology and triangular-type radiation system. it can generates high voltages pulse through digital control, making it easier to adjust polarity and magnitude of the E-field waveform.
- Replex's NEMP Simulator satisfies MIL-STD-461 E/F/G RS105 test requirements.

### ■ Features

- Order production according to EUT size
- Maximum electric field : 50kV/m or more
- E-field Variable : 5kV/m ~ Max. E-field Strength
- E-field Polarity : Plus(+), Minus(-)
- Rise Time (10~90%) : 1.8ns ~ 2.8ns
- Pulse Width (FWHM) : 18ns ~ 28ns
- Peak value of the E-field in the Test Area :  $0\text{dB} \leq \text{magnitude} \leq 6\text{dB}$  above limit
- Insulation : Nitrogen(N2) , Transformer Oil

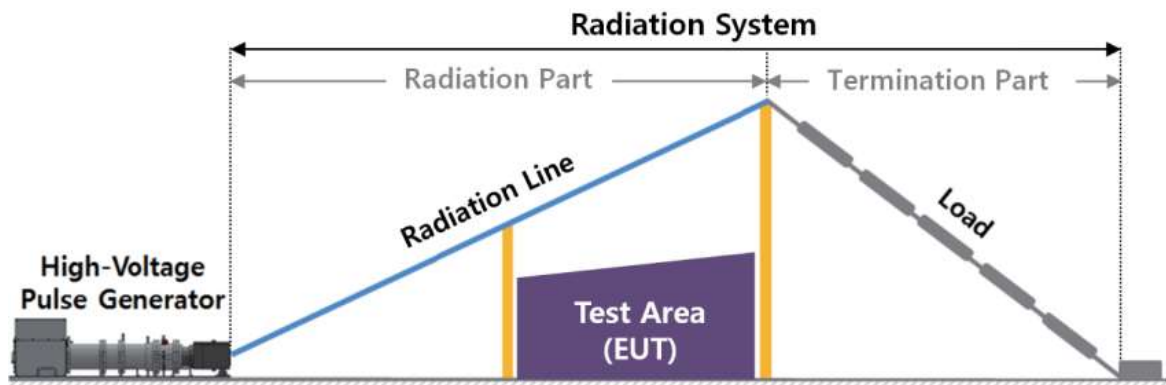
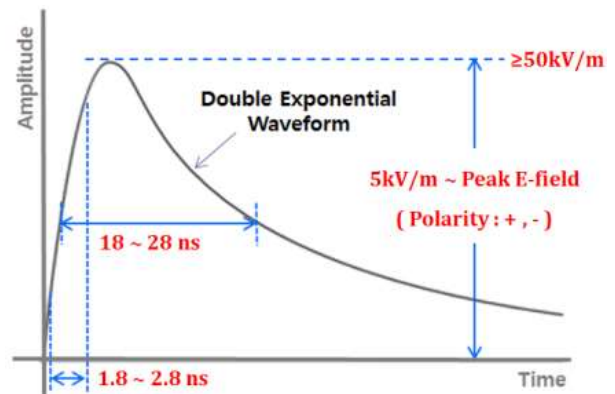

#### ■ Specifications



Parameter	Value
Model Name	NEMP-DCG-025KV
Standard	MIL-STD-461 E/F/G RS-105
Pulse Generator Voltage Range(Open Circuit)	2.5kV~25kV
Radiating Line Type/Impedance	Transmission Line/110Ω
Termination Type	Distributed Resistance
E-field waveform	Double exponential
E-field Pulse Rise Time(10%~90%)	1.8ns~2.8ns
E-field Pulse Width(FWHM)	18ns~28ns
Max. E-field Strength	50kV/m or more
E-field Polarization	Vertical
E-field Polarity	Positive(+), Negative(-)
Pulse Repetition Rate	1/min
Insulation of HV Pulse Generator	Transformer Oil
Power Rating	220VAC / 50Hz~60Hz
Storage/Working Temperature	5°C~50°C / 15°C~45°C
Dimension(L×W×H)	2.3m × 0.8m × 0.6m
Max. Test Volume(L×W×H)	15cm × 15cm × 15cm
Weight	~25kg

#### ■ Recommendation

The distance between top of the radiating line and the closest metallic ground(including ceiling, shielded room walls, and so forth) should be at least 2 times of the maximum height of the radiating line by the MIL-STD-461 E/F/G RS105.

■ NEMP Simulator Size

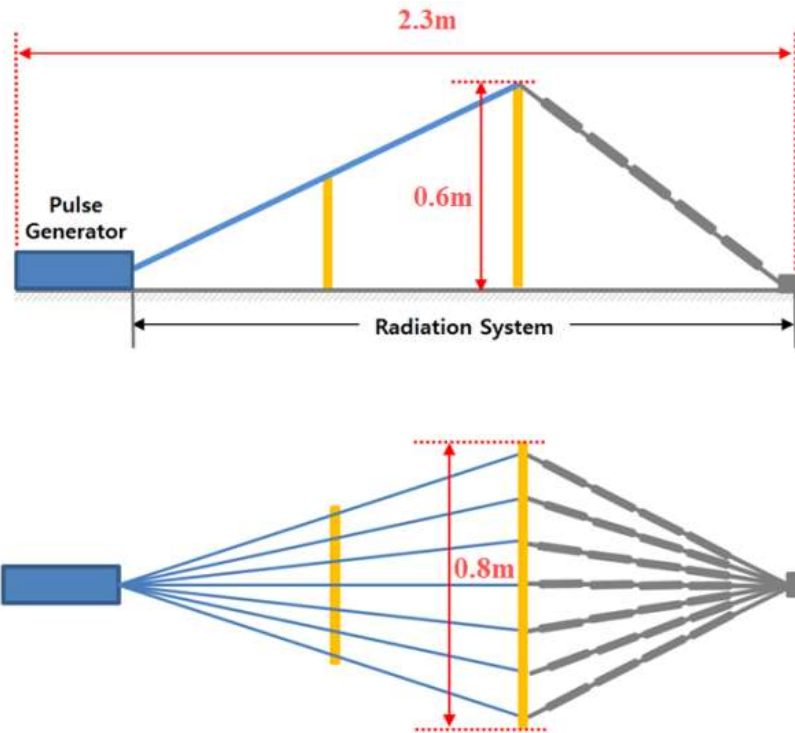

■ Test Volume Size

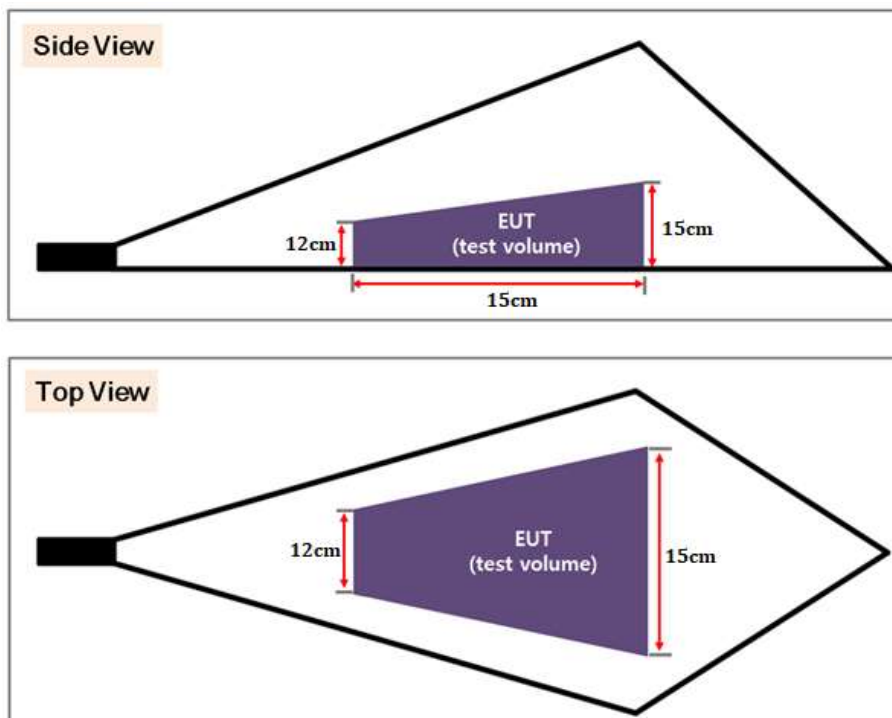

■ Measurement Waveform : Positive, 5kV/m(Minimum E-field Strength)

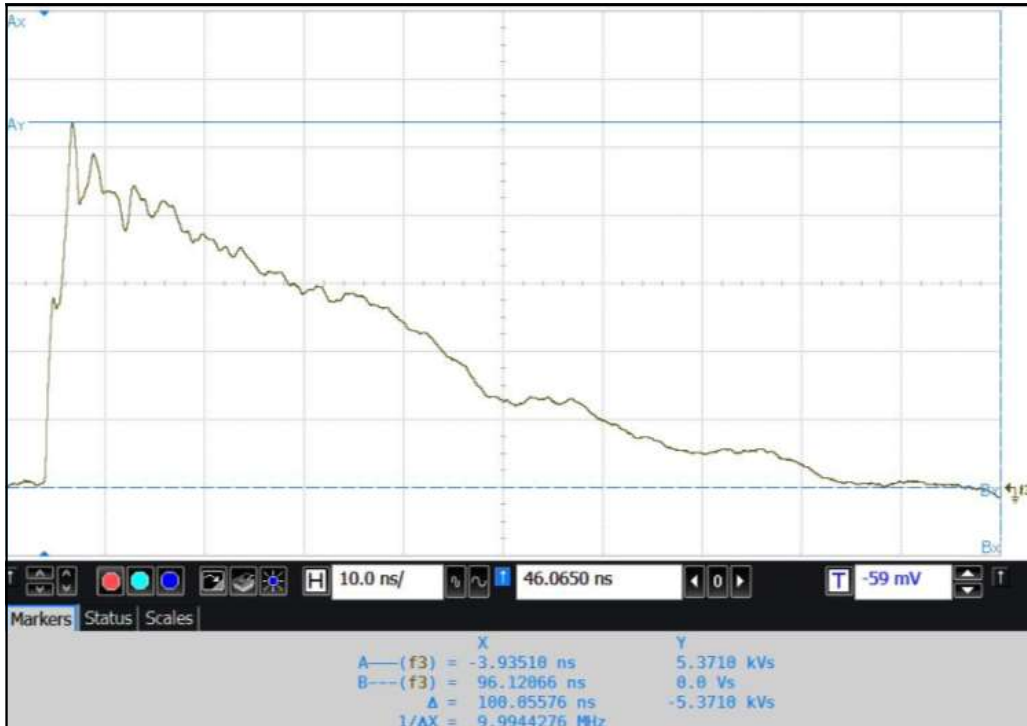

■ Measurement Waveform : Negative, 5kV/m(Minimum E-field Strength)

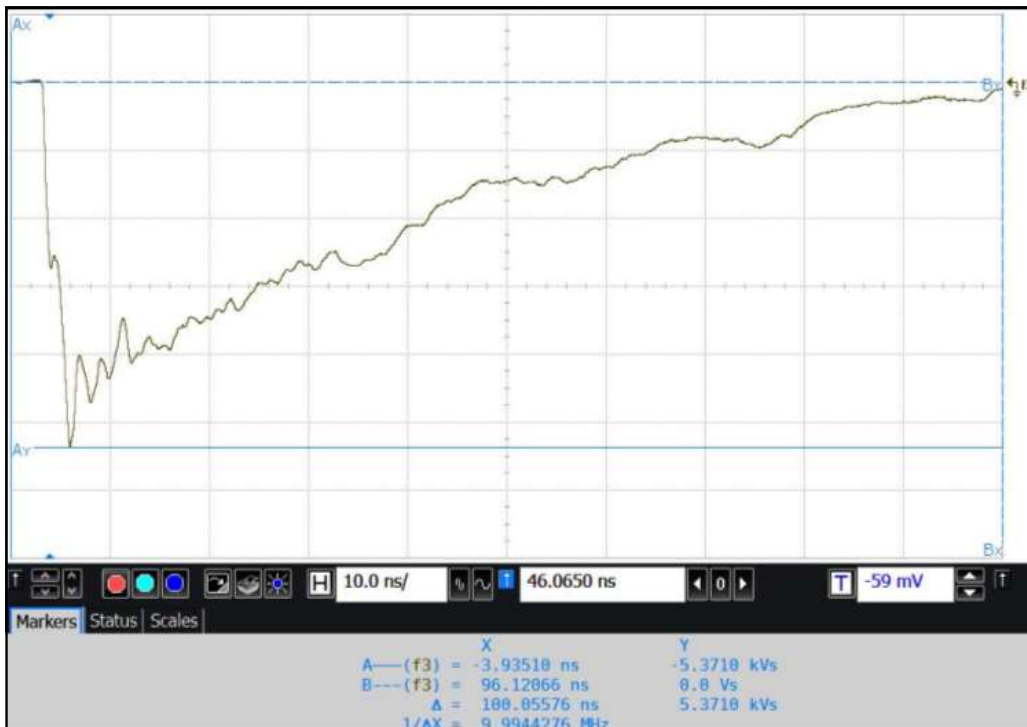

■ Measurement Waveform : Positive, 25kV/m

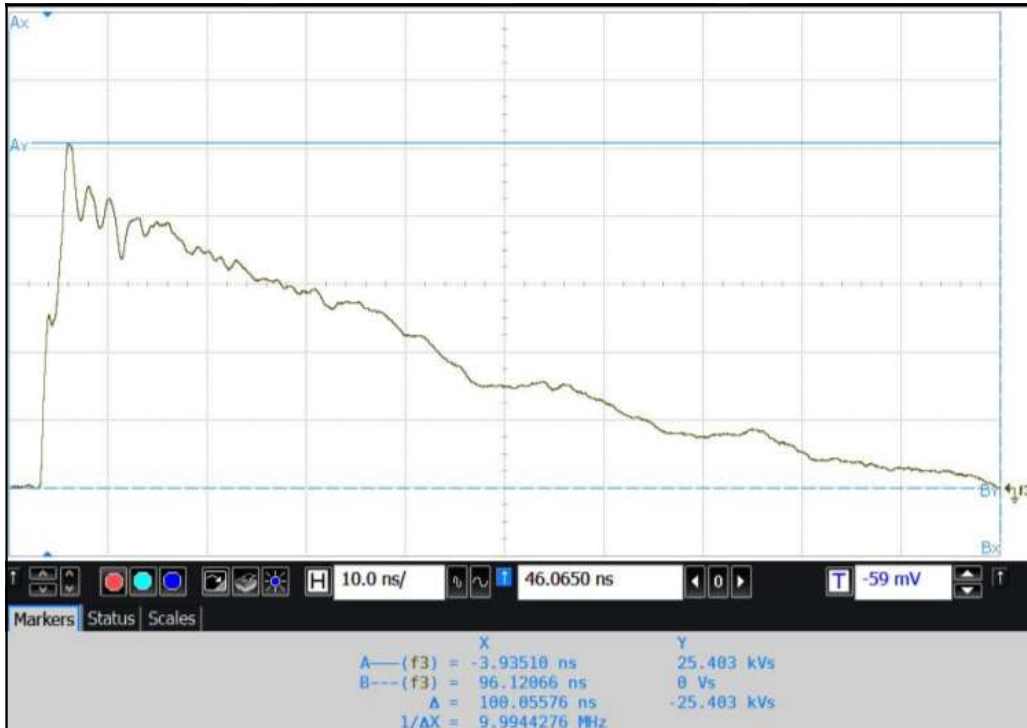

■ Measurement Waveform : Negative, 25kV/m

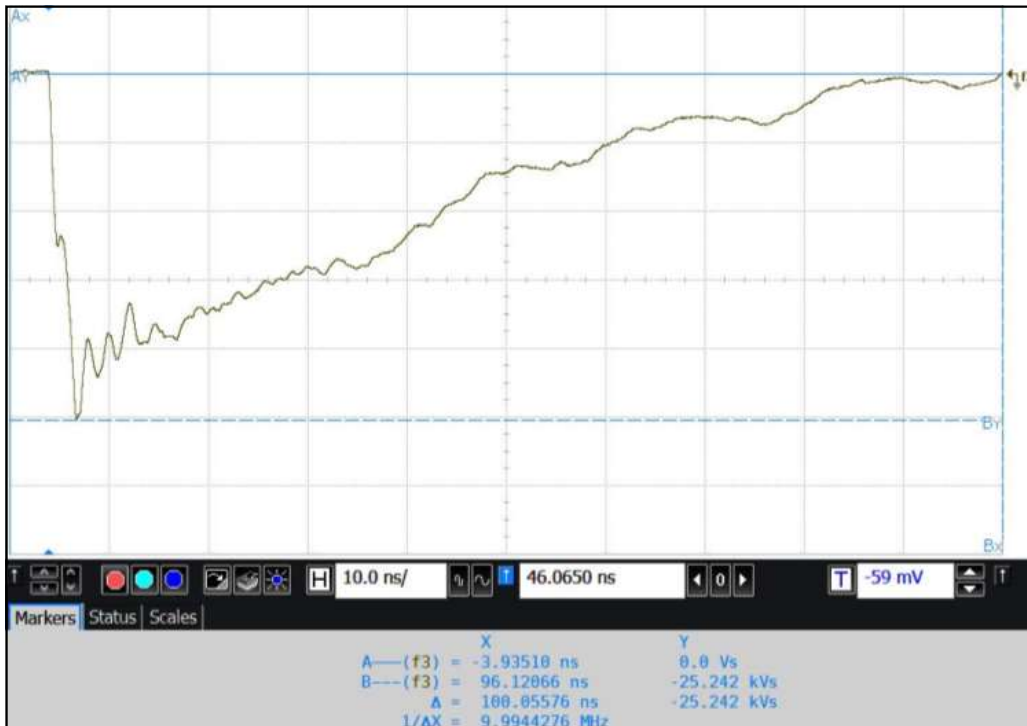

■ Measurement Waveform : Positive, 50kV/m(Maximum E-field Strength)

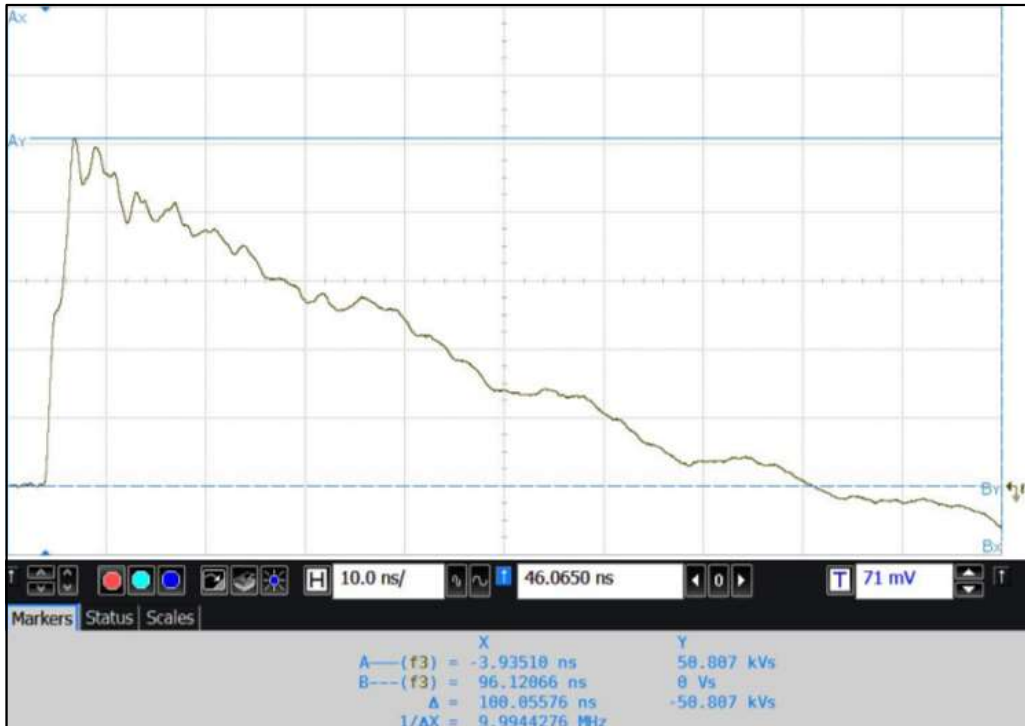

■ Measurement Waveform : Negative, 50kV/m(Maximum E-field Strength)

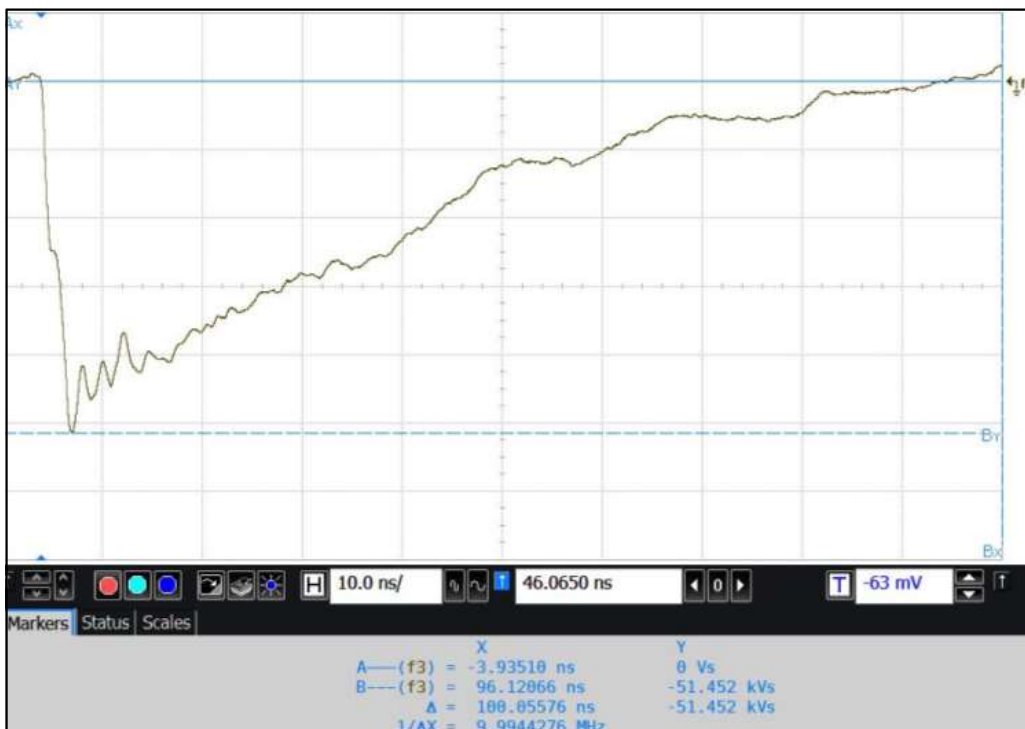

## NEMP Simulator Test & Measurement Configuration

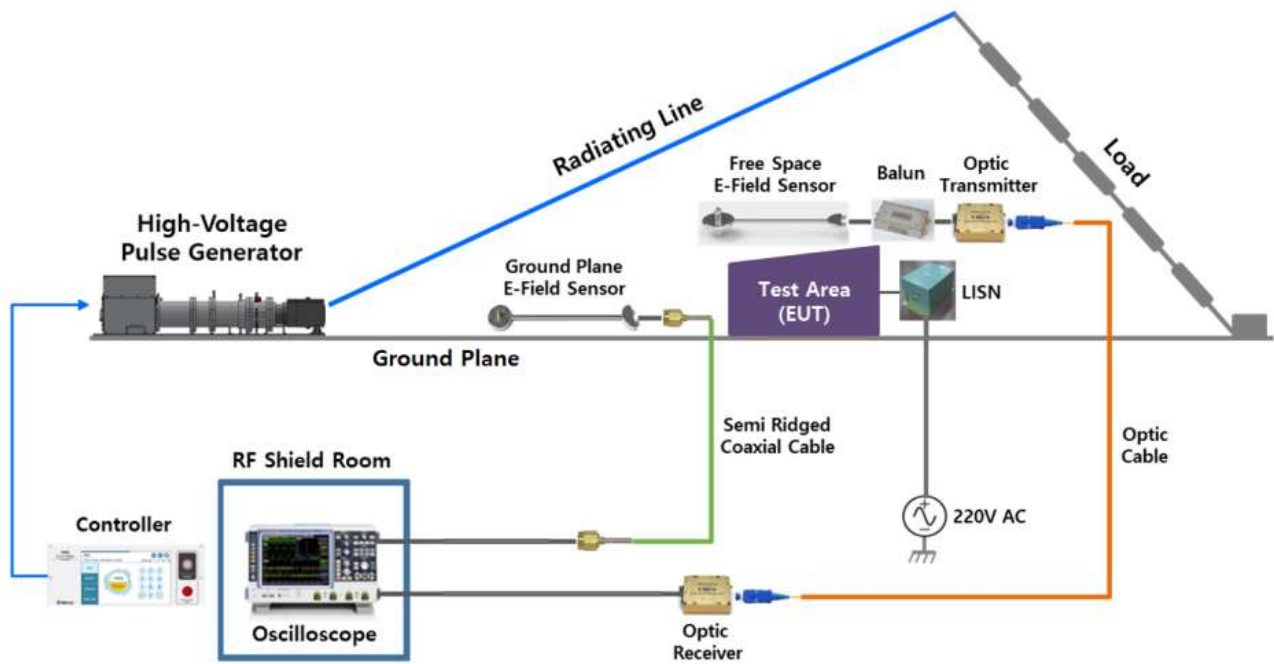

### 1. E-field Monitor System

- E-field monitor system is configure of the Free Space E-field monitor system and Ground Plane E-field monitor system.

#### ● Free Space E-field Monitoring System

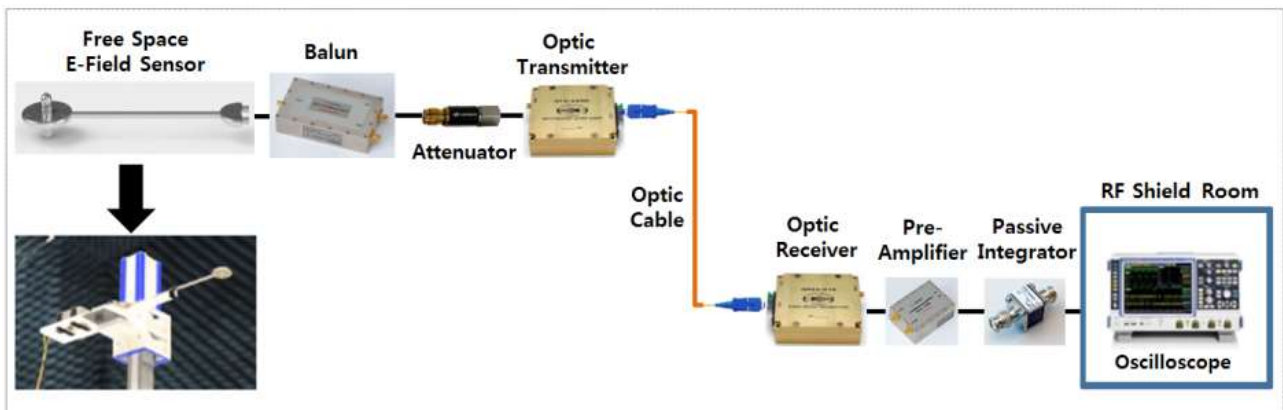

[ Free Space E-field Monitoring System ]

- Free space E-field monitor are made of derivative field sensors which can be place anywhere under the transmission line and are connected to the oscilloscope through optical link.
- Since the free space E-field sensor(D-dot sensor) has the characteristics to derivative the acquired waveform, it can be restored by connecting an passive integrator(H/W) to the oscilloscope's input channel or by means of a mathematical integral(S/W) of the oscilloscope's measured waveforms via the sensor.

#### ● Ground Plane E-field Monitor System

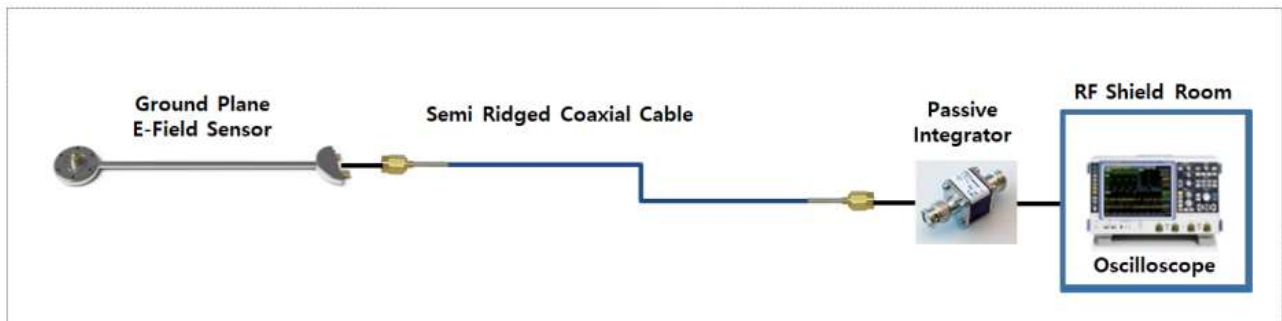

[ Ground Plane E-field Monitoring System ]

- Ground plane E-field monitor are made of derivative field sensors directly placed on the ground plane and are connected to the oscilloscope through coaxial cables and passive integrators. we recommend using a measurement with passive integrator.

## 2. Device Protection System

#### ● RF Shield Room(or Shield Box)

- It is recommended that the oscilloscope be installed and operated inside a shield room or shielded box to protect it from the powerful noise generated by the operation of the EMP generator.

#### ● LISN

- The LISN(Line Impedance Stabilization Network) are used to provide standardized impedance in common mode to the lines connected to the EUT.